

## 100W Constant Power Model LED Driver

### 产品特点 Product features:

- 全球通用电压范围 AC90-305V; Input voltage 90Vac-305Vac
- 效率高达 91%; With an efficiency of over 93%
- 恒流精度 ±5%; Constant current accuracy 5%
- 多种调光控制可选: 0-5V, 0-10V, PWM, 时控;  
Dimming control options: 0-5V, 0-10V, PWM, time control
- 独立的调光控制回路, 符合 UL8750 最新标准  
Independent dimming control loop, in line with the latest standard of UL8750
- 主动式 PFC 功率因数校正; PF ≥ 0.99 Input: 110Vac; PF ≥ 0.95 Input: 220Vac
- 内置输入过压、输出过压、短路保护; Protection functions :short circuit/OCP/OVP/OTP
- 雷击浪涌差模 6KV, 共模 8KV; Lightning surge differential mode 6KV, common mode 8KV
- IP 等级高达 67, 适用于干燥、潮湿、淋雨环境; IP67
- 质保 5 年; 5 years warranty



### 产品描述 Product description:

JG-100PL-XX \* 系列为 100W 恒流驱动器产品, 其输入电压范围为 90-305Vac, 且具有超高的功率因数。此系列产品是专为工矿灯, 高杆灯, 球场灯及路灯而设计, 并具有可调光关断的功能, 且待机功耗低。超高的效率, 紧凑的外壳设计, 良好的散热, 极大地提高了产品的可靠性, 并延长了产品的寿命。全方位的保护, 包括防雷保护、过压保护、短路保护, 更是保证了此款产品的无障碍运转。

The 100W constant current driver product has an input voltage range of 90-305Vac and an ultra-high power factor. This series of products is specially designed for industrial and mining lamps, high pole lamps, stadium lamps and street lamps, and has the function of dimming and turning off, with low standby power consumption. Ultra-high efficiency, compact shell design and good heat dissipation greatly improve the reliability and prolong the service life of products. All-round protection, including lightning protection, overvoltage protection and short circuit protection, ensures the barrier-free operation of this product.

### 产品型号 Model list:

型号 Model	输入电压 Input Voltage	输出电压 Output Voltage	输出电流 Output Current	输出功率 Rated power	总谐波失真 THD	功率因数 PF	转换效率 Eff
JG-100PL-48*	90-305Vac	27-48VDC	1.2-3.0A	100W	8%	0.97	91%
JG-100PL-80*	90-305Vac	40-80Vdc	0.6-1.8A	100W	8%	0.97	91%

1、测试条件均在 230Vac 输入, 输出满载, 环境温度 25°C。

Efficiency was tested at 220Vac input full load.

2、产品型号后缀字母表示: D 代表支持三合一调光, 即电阻、0-10V、PWM(推介 1K 频率), T 代表时控调光(支持多时段调光功能), C 代表多程控式(电流设置、1-5V、1-10V, 过温设置、运行记录、开关次数、定时调光、故障检测等功能), 空位(默认)代表为基础机型(手动电流可调)。

The suffix letter of the product model indicates: D stands for supporting three-in-one dimming, that is, resistance, 0-10V, PWM (1K frequency recommended), T stands for time-controlled dimming (supporting multi-period dimming function), C stands for multi-mode program-controlled type (current setting, 1-5V, 1-10V, over-temperature setting, operation record, switching times, timing dimming, fault detection, etc.), and vacancy (default)

3、低压输入情况下需降额输出，具体参考降额曲线图。

Under the condition of low voltage input, derating output is required. Refer to derating graph for details.

4、为达到时工作寿命大于 50000 小时，电源的 Tc 点温度应 < 75°C，具体参考壳温与寿命曲线图。

In order to achieve a working life of more than 50,000 hours, the Tc point temperature of the power supply should be < 75°C. Refer to the graph of shell temperature and life for details.

### 输入特性 Input characteristics:

参数 Parameter	最小值 Min	典型值 Typ	最大值 Max	备注 Remarks
额定输入电压 Input Voltage	100Vac	----	277Vac	----
输入电压 Output Voltage	90VAC	----	305VAC	----
输入电流 Input Current	----	----	1.1A	110Vac, 100% Load
	----	----	0.5A	230Vac, 100% Load
输入频率 Input frequency	47HZ	50HZ	63HZ	----
功率因数/PF	----	----	0.99	230Vac, 100% Load
谐波失真/THD	----	7%	<10%	
漏电流 Leakage current	----	----	<1mA	277Vac
输入浪涌电流 Surge current	----	----	33A	230VAC, 100% Load

### 输出特性 Output characteristics:

参数 Parameter	最小值 Min	典型值 Typ	最大值 Max	备注 Remarks
恒流精度 current accuracy	-5%	----	+5%	230Vac, 100% Load
输出电流设置范围 Output current setting range	1200mA	----	3000mA	----
	600mA	----	1800mA	----
输出纹波电流 Ripple current (Ip-Ip)	----	----	10%Io max	230Vac, 100% Load
启动过冲电流 Output overshoot	----	----	5%Io max	230Vac, 100% Load
负载调整率/Load adjustment rate	-1%	----	+2%	230Vac, 60-100% Load

线性调整率 Linear adjustment rate	-1%	----	+1%	110~277Vac, 100% Load
输出电压 Output Voltage	27Vdc	----	48Vdc	----
JG-100PL-48*	40Vdc	----	80Vdc	----
JG-100PL-80*				
启动时间 start time	----	0.8S	2S	230Vac, 100% Load
温度系数 temperature coefficient	-0.08%	----	0.08%/°C	Tc=0°C~Tc Max

**保护功能 Protection function:**

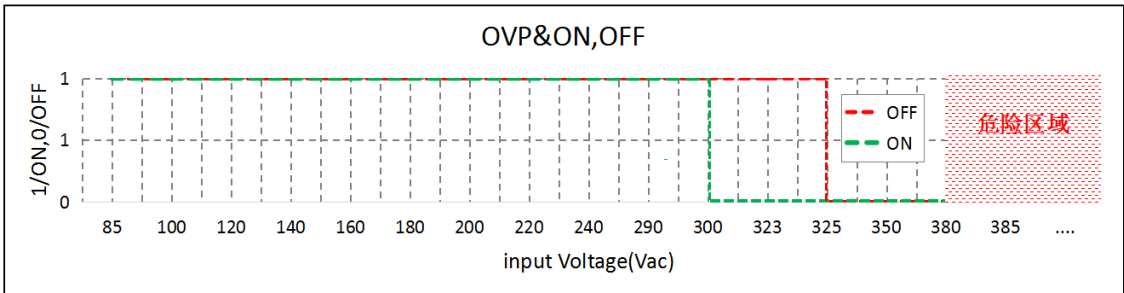
参数 Parameter	最小值 Min	典型值 Typ	最大值 Max	备注 Remarks
短路 Short circuit	输出正负极短路, 故障解除后恢复正常 The short circuit has no damage, and the short circuit can be released automatically.			
输入欠压 Input undervoltage	----	----	----	输入电压>100Vac 时电源重新启动 When the input voltage is > 100Vac, the power is restarted
输入过压 Input overvoltage	323Vac	----	325Vac	输入电压<290Vac 时电源重新启动 When the input voltage is less than 290Vac, the power is restarted
	 <p style="text-align: center;"><b>OVP&amp;ON,OFF</b></p> <p style="text-align: center;">1/ON,0/OFF</p> <p style="text-align: center;">input Voltage(Vac)</p>			
输出过压 Output overvoltage	----	----	60Vdc 100Vdc	故障解除后恢复正常
JG-100PL-48*				
JG-100PL-80*				
空载保护 No-load protection	----	----	62Vdc 100Vdc	----
JG-100PL-48*				
JG-100PL-80*				
雷击保护 Lightning protection	----	6KV	8KV	220Vac, Line-Line

**调光特性 Dimming characteristics:**

参数 Parameter		最小值 Min	典型值 Typ	最大值 Max	备注 Remarks
0-10V DIM (Suffix D)	外加输入电压 Input Voltage	0V	0-10V	15V	Can be customized according to customer needs
	输出电流 Output Current	0%	----	100%	
PWM DIM (Suffix D)	PWM Output	-0.3V	0-10V	15V	The frequency of 1KHZ is recommended.
	PWM	200HZ	----	2KHZ	
	Output Current	0%		100%	
Resistance DIM (Suffix D)	Resistance	0R		100K	
	Output Current	0%		100%	
Timing DIM (Suffix T)	单段定时调光, 4 小时后降 50%输出功率 Single-stage timing dimming, reducing output power by 50% after 4 hours				Can be customized according to customer needs
	多时段定时降功率调光: 动作时间为 4, 5, 6, 7, 8 小时后分别降 20%, 30%, 40%, 80%, 60%输出功率 Multi-period timing power reduction and dimming: the output power is reduced by 20%, 30%, 40%, 80% and 60% respectively after the action time is 4, 5, 6, 7 and 8 hours				

**环境要求 Environmental requirements:**

参数 Parameter	最小值 Min	典型值 Typ	最大值 Max	备注 Remarks
工作温度 Working temperature	-40℃	25℃	+60℃	
储存温度 storage temperature	-40℃	25℃	+80℃	
工作湿度 Working humidity	10%RH	----	90%RH	
储存湿度 Storage humidity	5%RH	----	95%RH	
储存时间 Storage time	----	----	1year	

**规格概述 Overview of specifications:**

参数 Parameter	最小值 Min	典型值 Typ	最大值 Max	备注 Remarks
空载功耗 No-load power	----	----	<2W	230Vac
MTBF	-----	280,000Hours	-----	230Vac 环温 25℃, Full Load
使用寿命 Service life	-----	50,000Hours	-----	230Vac, Full Load, 壳温 70℃
尺寸/Size	0.5kg			----
净重/Weight	164*53*33			长 x 宽 x 高

**安规与电磁兼容 Safety Regulations and Electromagnetic Compatibility**

项目 Projects	标准 Standard		备注 Remarks
安全规范 Safety	UL8750, EN61347-2-13, EN61347-1, GB19510.14		
耐压 HI-Pot	I/P-O/P:3.75KVAC I/P-FG:1.6KVAC O/P-FG:1.6KVAC		
绝缘阻抗 HI-Pot	I/P-O/P, I/P-FG, O/P-FG:100MOhms/500VDC/25°C/70%RH		
接地电阻 HI-Pot	<100mR, 20A/1min		地线与外壳
电磁兼容与发射; 电磁兼容抗扰度 MEC&EMI	传导 CE	EN55015 (CISPR15) ,GB/T17743	
	辐射 RE	EN55015 (CISPR15) ,GB/T17743	
	谐波电流 Harmonics	EN61000-3-2 , GB/T17625.1	CLASS C
	电压闪烁 Voltage flicker	EN61000-3-3	
	EN61547		
	静电放电抗扰度试验 ESD	EN61000-4-2	Level3, 8KV air;Level2, 4KV contact
	辐射、射频、电磁场免疫 RFF	EN61000-4-3	Level3
	电快速瞬变~2A 突发脉冲 群免疫试验//EFT	EN61000-4-4	Level3
	抗浪涌免疫试验 Surge	EN61000-4-5	6KV/Line-Line 8KV/Line-Earth
	射频场感应的传导干扰 CRF	EN61000-4-6	Level4
工频磁场抗扰度试验 Power Frequency Magnetic Field Test	EN61000-4-8	Level3	
电压跌落和中断试验 Voltage Dips	EN61000-4-11		

电参数曲线图 Electrical parameter graph:

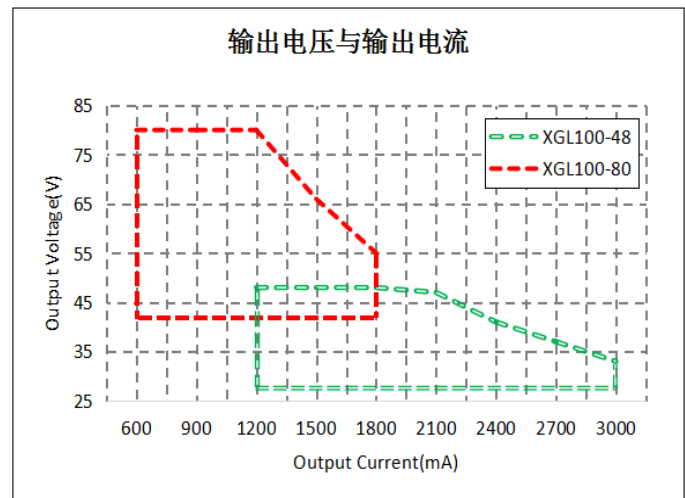
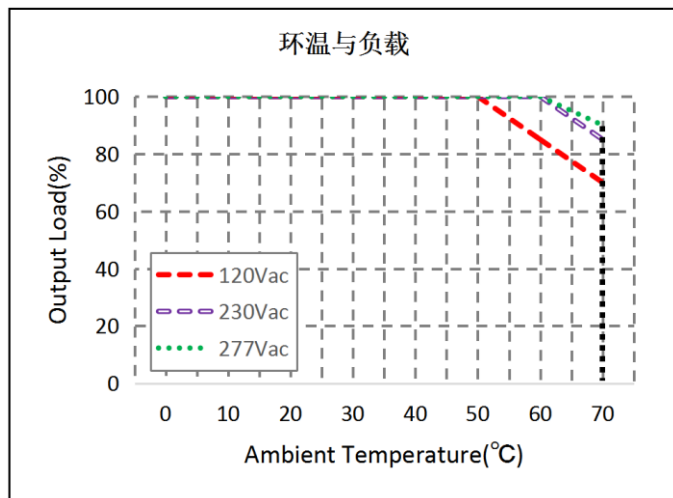
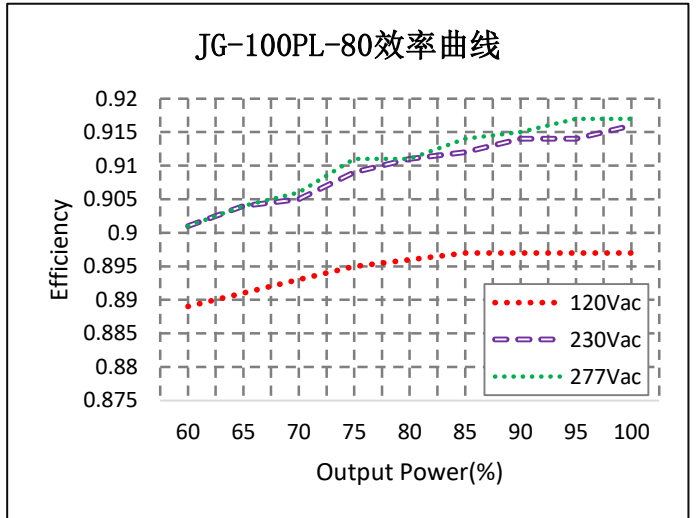
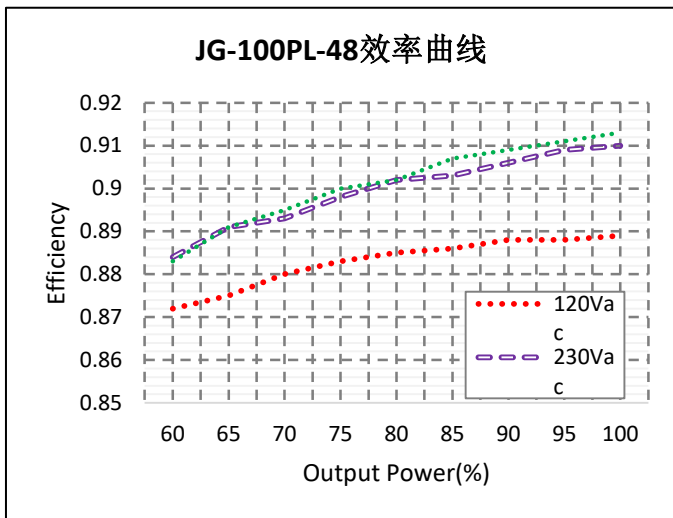
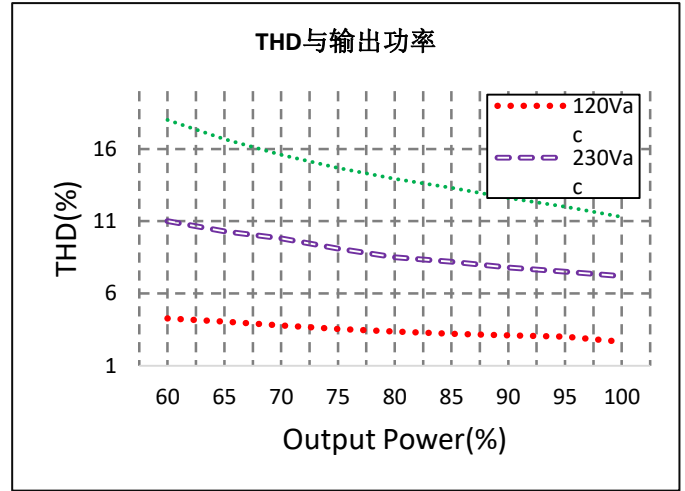
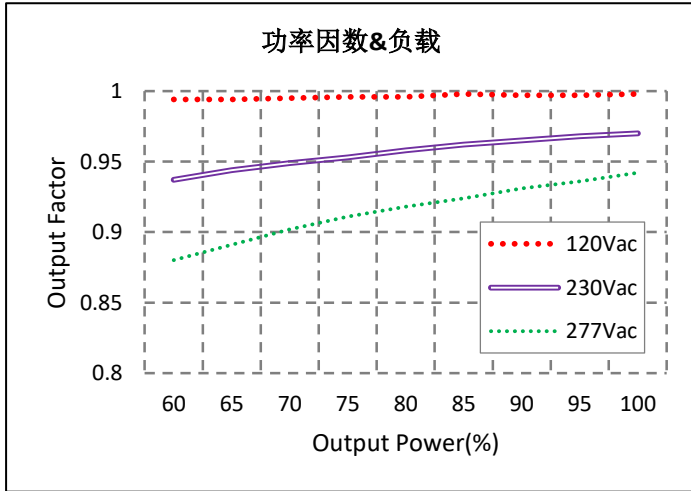

降额曲线



壳温与寿命关系曲线图

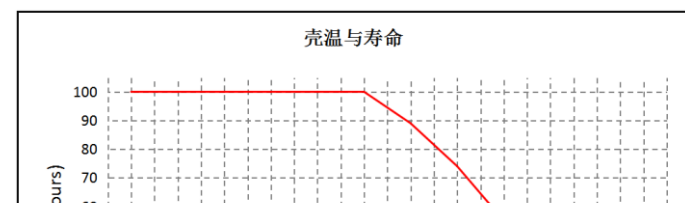

## 调光说明 Description of dimming

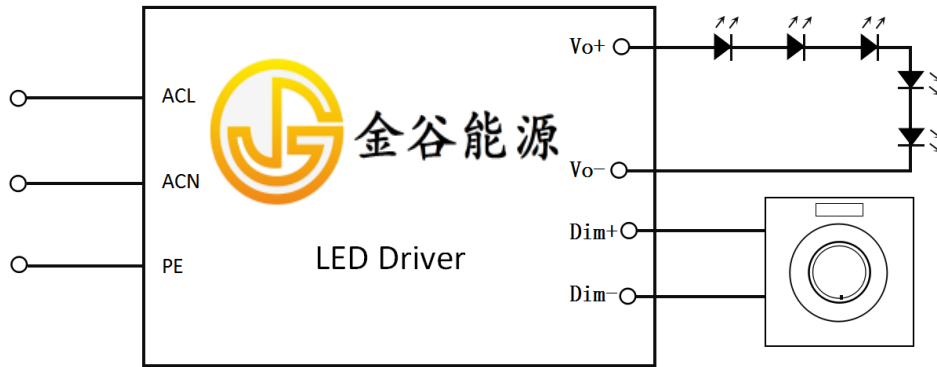

三合一调光功能(仅后缀带 D 型)

在 DIM+和 DIM-间连接一个电阻或连接 0 ~ 10V 直流电压或 10V PWM 信号或电阻, 即可调整输出恒电流的数值  
调光端口输出电流: 200  $\mu$  A(典型值)

※请勿将“DIM-”与“Vo-”连接

Three-in-one dimming function (only suffix with D type) The output constant current can be adjusted by connecting a resistor between DIM+ and DIM- or connecting 0 ~ 10V DC voltage or 10V PWM signal or resistor  
Output current of dimming port: 200  $\mu$  A (typical value)

※Do not connect “DIM-” with “Vo-”.

PWM 调光:Dim 线外接 10V(200HZ-2KHZ)调光信号

0-10V 调光:Dim 线外接 0-10V 调光电平

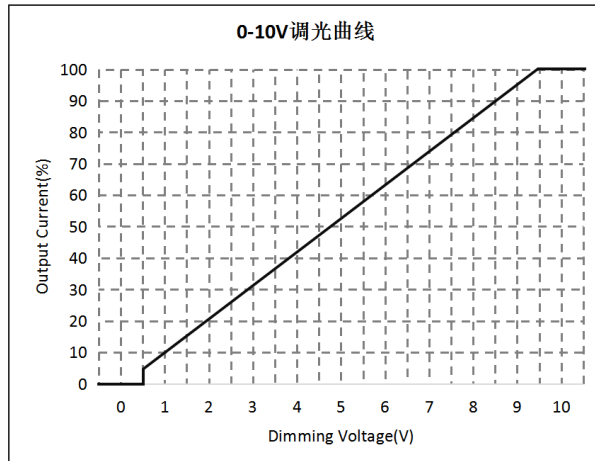
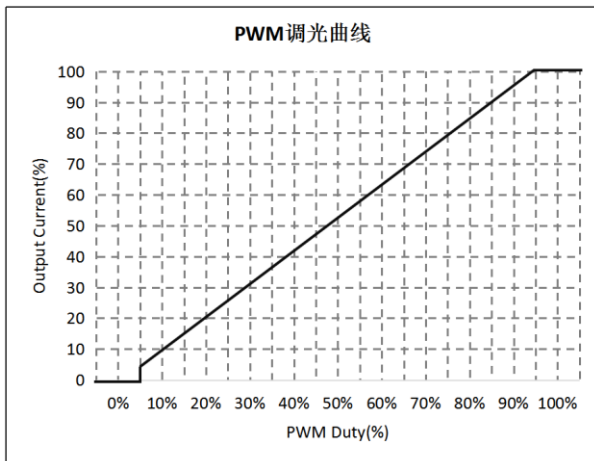

电阻调光:Dim-与 Dim+串联 0-100K 电阻调光

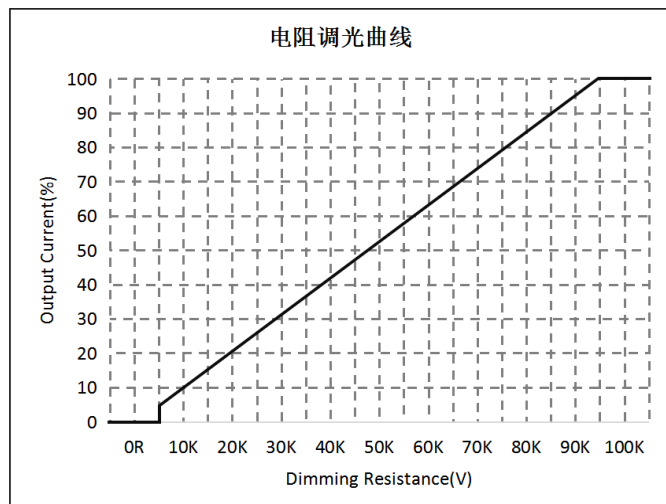

产品尺寸图 Product dimension drawing:

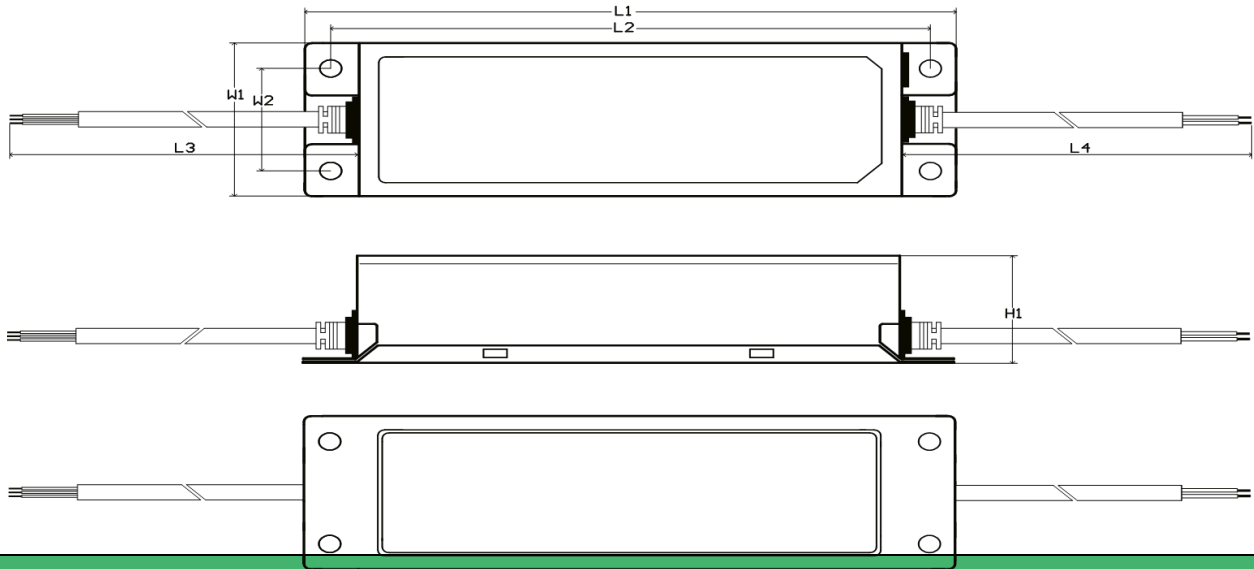

规格说明（后缀不带字母系列） Specification (general)

L1 (外壳长)	L2 (螺丝定位孔)	L3 (输入线)	L4 (输出线)	W1 (外壳宽)	W2 (螺丝定位孔)	H1 (外壳高)
164mm	150mm	400mm	350mm	53mm	34mm	33mm

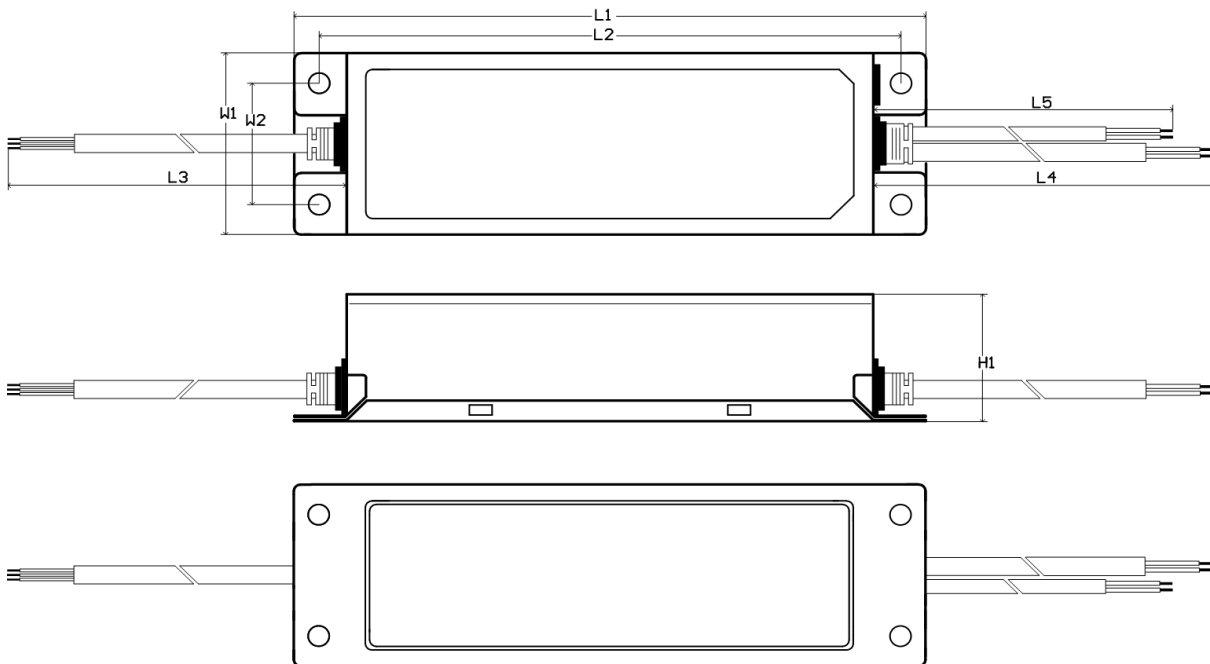

规格说明（后缀带 D 字母系列） Specification (DIM)

L1 (外壳长)	L2 (螺丝定位孔)	L3 (输入线)	L4 (输出线)	L5 (调光输入线)	W1 (外壳宽)	W2 (螺丝定位孔)	H1 (外壳高)
164mm	150mm	400mm	350mm	300mm	53mm	34mm	33mm